

High Pressure Air Cushion Machine User Manual LA-F2



Hangzhou Bingjia Technology Co., Ltd.
**7th Floor, Building 11, Artificial Intelligence Town, No. 1818-2 Wenyi West
Road, Yuhang District, Hangzhou City, Zhejiang Province**

Content

Preface	I
Safety	II
Operator	II
1. Introduction	1
1.1. Product Introduction	1
1.2. Unpacking List	1
2. Operation	2
2.1. Power On	2
2.2. Feeding	2
2.3. Start And Stop	3
2.4. Power Off	4
3. Detailed Operatio	5
3.1. Control Panel Instructions	5
3.2. Main Interface	5
3.3. Set The Temperature	6
3.4. Set The Air Volume	6
3.5. Set The Speed	6
3.6. Parameter Locking Function	7
3.7. Set Up Operation Mode	7
3.8. Select Sizes	8
3.9. Auxiliary Function	8
4. Fault Analysis And Diagnosis	9
4.1. Error alarm introduction:	9
4.2. Common Faults And Troubleshooting	10
4.3. Engineering Interface Operation Instruction	11
5. Specification	13
5.1. Basic Specifications	13
6. Maintenance	14
6.1. Repair/Replacement Parts	14
6.2. Replace Heating Belts	15
6.3. Replace The Blade	16

Preface

Thank you for using the Locked Air High Pressure Air Cushion. In order to ensure that you use the equipment correctly, be sure to read this manual carefully before operation.

Tips: The operation of different models of machines is slightly different, so please pay attention to the tips in the text of the manual.

Disclaimer

The manufacturer and its authorized distributor are not liable for any accidents or damages if one does not follow the operation steps or ignores the warning or instructions in the manual. The accidents or damages includes:

- Improper use or maintenance
- Use for other applications or conditions that the operator manual doesn't include
- Use of unauthorized parts
- Repair or modification without the permission of the manufacturer
- Unauthorized adjust to the machine such as:
 - a) Alterations to the control system
 - b) Welding and machining etc
 - c) lengthening the machine or the control system

The manufacturer and its authorized distributor are not liable for:

- Indirect damages caused by errors or malfunctions of the machine (e.g. damages to products, disruption or delays of company operation business etc.)

Safety

This machine has been designed to be compatible and safe for use in the application, conditions and rules stipulated in this instruction manual. Anyone who operates the machine must carefully read this manual and follow the relevant instructions.

Operator

Only anyone who has read and understood the chapters of "Safety" and "Installation and Use of the Machine" could operate the machine. No special training is required.

Operator responsibilities include:

- Operate machine
- Perform regular maintenance (see Section 6)

Service Technician

Only service technicians employed by Locked Air or Locked Air distributors are permitted to repair this machine.

We have separately prepared service manuals for these technicians.

Safety Regulations

The power used for the machine must be consistent with the parameters on the nameplate of the machine. Wrong connection is strictly prohibited. In order to prevent damage to the machine, only the power cord provided with the product can be used .

Please ensure that the power supply is reliably grounded.

When the machine is transported and moved, please pay attention to avoid occurrence of the short-circuit and open-circuit of the internal wiring of the safety switch.

Safety devices must not be turned off or removed.

Do not remove or cover warning signs (see machine warnings).

Keep the work area clean and free from obstacles.

Before moving the machine, unplug it and gather all loose wires together.

Be careful when using tools such as knives or scissors to avoid injuring your hands.

To ensure:

- No damage to cables
- Work area with good lighting

- Work area is well ventilated

Safety standard design: mechanical structure design meets CE safety standard requirements. All dangerous parts cannot be touched by hand.

Machine Warnings

- a. It is strictly forbidden to touch any rotating parts when the machine is working;
- b. It is strictly forbidden to touch the high temperature area with the warning when the machine is working and stops working in 5 mins;



- c. Please press the emergency stop button and shut off the power if any the followings happen:
 - The machine film or any other foreign material caught inside the machine, the machine doesn't work
 - There is abnormal sound inside the machine.
 - Abnormal heating, the temperature of shell is too high.
 - Other abnormal situations

Improper Use

The following applications or operations are inappropriate for the machine and are regarded as improper use:

- Use materials from other suppliers, not from Locked Air
- Use outdoors or in wet areas
- Use in areas where explosion accidents may occur
- Use excess water to wash or clean the machine
- Stand on the machine
- Place objects on the machine
- Move the machine while it is running or it is still connected to AC power

Store

- Storerooms must be dry
- Do not place or store the machine in a wet or watery place
- Before using the machine again after long-term storage, it must be checked by a

trained service technician



If the machine is brought from a cold area to a warm area, temporary condensation (internal and external) may occur on the machine. At this time, if it is turned on immediately, the machine would be damaged and the operator would be injured. So please make the machine recover to room temperature first and wait for the condensation to evaporate.

Transportation

- There should not be severe vibration and impact during the transportation of the machine.
- The machine should not be exposed to the sun and rain. It should be stored within the required temperature and humidity range

1. Introduction

1.1. Product Introduction

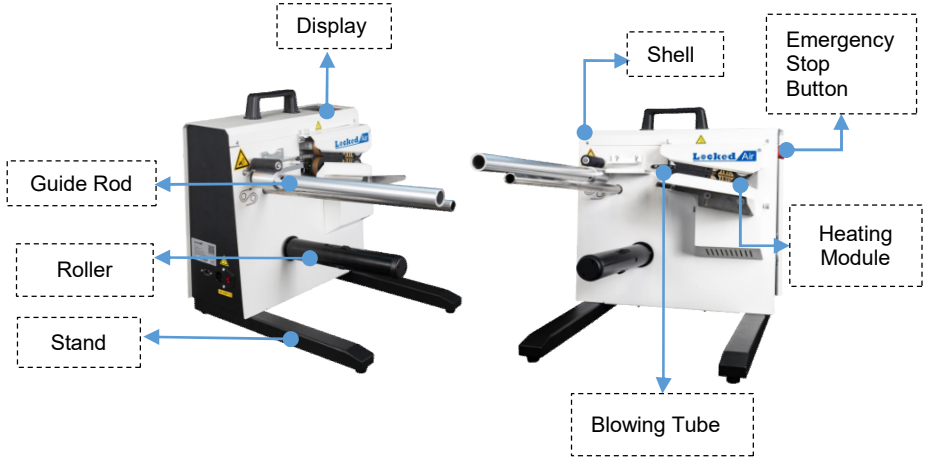

1.2. Unpacking List

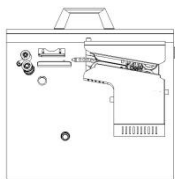

×1
Body of F2



×1
Roller



×2
Stand

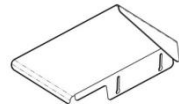

×1
Holding Board



×1
Guide Rod A



×1
Guide Rod B



×1
Power Cable

2. Operation

2.1. Power On

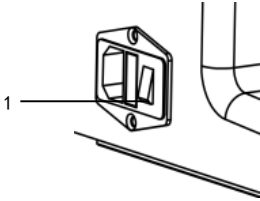

1. Check and make sure the emergency stop button is off(released);
2. Plug the power supply to a ground-protected single-phase three-wire socket.
3. Turn on the power switch 1.

2.2. Feeding

1)

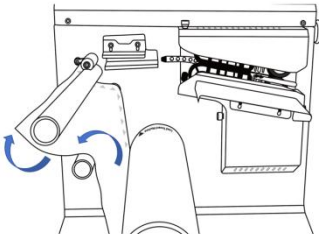

Place the air cushion film on the mandrel, with the inflatable end close to the machine, lead the film through the middle of the 2 guide film rods.

2)

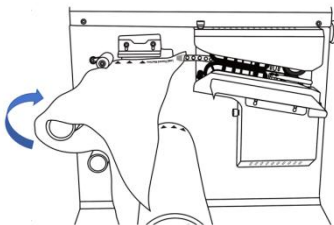

And then sleeve the air cushion film opening to the nozzle, drag the film toward the arrow direction to reach the gap between upper and lower heating belts.

3)

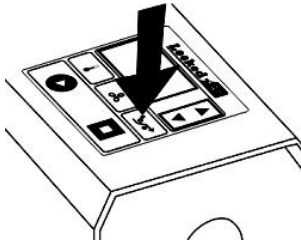



When the machine is in a stop state, press the loading button  to enter the film-loading mode, at this time the upper and lower belts will pull the air cushion film slowly forward to a certain distance and then stop automatically.

Tips:

- (1) Press loading button again under the loading mode ,belt will stop rotating and exit loading mode.
- (2) Long press the loading button , the heating belt will keep running until the button is released.
- (3) When you press the start button  to start the machine, you will exit loading mode.

2.3. Start And Stop

- (1) **Start** Press start button  and the heating wire heats up. This process lasts 5 ~10s, depending on the environment temperature. The device starts after the temperature reaches the set value.
- (2) **Stop** Press Stop Button , Machine Stops, Heating Wire cools down.

Note: Do not touch any high temperature area and rotating parts of the machine during operation or within 5 minutes after the machine stops.

2.4. Power Off

- (1) When the machine is in stop state, rip off the film close to the machine.
- (2) Long press the film loading button  to drain the air cushion film that remains in the machine.
- (3) Turn off power switch .

3. Detailed Operatio

3.1. Control Panel Instructions

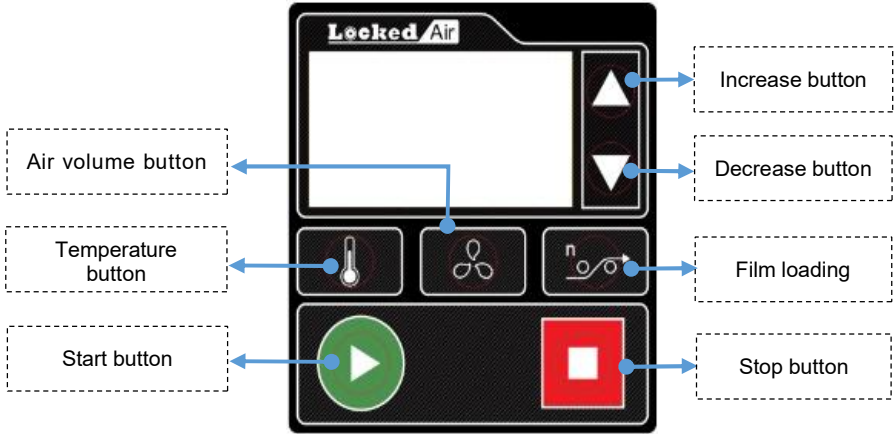

3.2. Main Interface

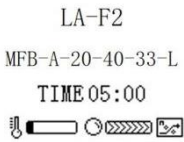





- a. The control panel displays as left picture when power on. The middle of screen shows current working mode, means the heating status, means working status, means film loading status .

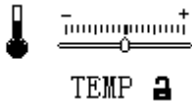

- b. The upper left interface indicates that the machine is stopped,press start button ,machine displays the bottom left interface,start heating,machine starts to work when is full,and arrow starts to move .

3.3. Set The Temperature





- a. Press temperature button , and enter temperature setting interface, press increase button  or decrease button  can increase or decrease the temperature under this interface.

Note: thicker font is system default, same as below.

3.4. Set The Air Volume





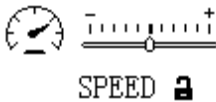

- a. Press air volume button , and enter air volume setting interface, press increase button  or decrease button  can increase or decrease the air volume under this interface.

Note: machine with external pump does not support this operatio

3.5. Set The Speed







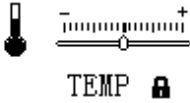

- a. Press temperature button , and decrease button , and enter speed setting interface, press increase button  or decrease button  can increase or decrease speed under this interface.

3.6. Parameter Locking Function

Locking function is available on the parameter of temperature, air volume and speed, which can be used to avoid wrong parameter due to incorrect operation.



a. As shown in upper left figure, the “Lock” icon () displayed in parameter interface indicates that, this parameter has been locked already, and it is invalid to press “Increase” button  or “Decrease” button  at this time.

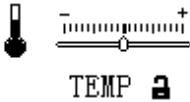

b. Unlock: After the parameter was locked, press “Stop” button , you will hear continuous humming, continue to press this button until the icon become , the parameter will be unlocked. Loose “Stop” button  to change this parameter.



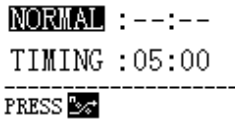

c. Lock: Press “Stop” button  in the parameter interface for a long time can lock the parameter manually. Or the machine will lock up automatically after a period of no button operation, parameters can not be set after being locked.

3.7. Set Up Operation Mode



a. Press “Air volume setting” button  and “Decrease” button  in the main interface simultaneously to enter into selection interface of operation model.

b. Press “Trans-film” button  to shift from “Continuous model” to “Timing model”.

c. If selected “Timing model”, click or press “Increase” button  or “Decrease” button  for a long time enables to set the duration of timing.

d. After selected the operation model, press “Stop” button  to exit.







3.8. Select Sizes

1. MFB-A-16-40-33-L

2. MFB-A-26-80-33-C

3. MFF-A-16-40-17-L

4. MFF-A-26-40-34-L

- a. Press "Air volume" setting button  and "Decrease" button  simultaneously to enter into the interface of specification selection. Different specifications can be shifted by pressing "Increase" button  or "Decrease" button  for about 3 seconds, then the corresponding selected parameter will be displayed on the right side of interface and become valid immediately.



- b. After selected the specification, press "Stop" button  to exit such interface, then the machine will run according to the selected parameters.

Note: Specification is only required to be changed when changing the size of air cushion film. Do not change the parameter at random in any other cases.

3.9. Auxiliary Function

In main interface, when the machine is stopped:



- a. Click "Trans-film" button , the temperature of machine will not be increased, but the heating belt will run for trans-film assistance. After a certain length of film has been transported, the heating belt will be stopped automatically. Or you can click the "Trans-film" button  again to stop the machine manually.

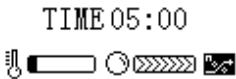

- b. Press the "Trans-film" button  for a long time, the temperature of machine will not be increased, but the heating belt will run continuously. Loosen this button, the machine will stop, and the residue air cushion film can be removed from machine.

4. Fault Analysis And Diagnosis

4.1. Error alarm introduction:

Error code	Wrong meaning	Trigger principle
EF01	Fan signal is abnormal	When starting, the Hall signal detection is abnormal
EF02	Fan overcurrent	Continuous 500ms exceeding the maximum current
EO01	Film broken alarm	The slot photoelectric sensor has no signal change for 3.5S
EO02	Power voltage overflow	Switching power supply output voltage > 25.5V or drive PCB failure
EH01	Warming timeout	Based on the initial temperature calculation, the time for the heating wire to rise to a steady state is timed out
EH02	NTC heating slope is too low	When the device is cold started, the temperature rise of the NTC is very slow
EH03	NTC temperature overflow	The NTC temperature sensor is abnormal, the temperature is >150°C or <-40°C
EH04	Continuous low power output	Heating wire continuous 2S 5% output
EH05	Continuous high power output	Heating wire continuous 2S 30% output
EH06	Short circuit	Heating wire current becomes larger
EH07	NTC temperature jump >30°C	NTC temperature sensor damaged or drive PCB problem

EH08	Current high level 2.5S	The MOS or operational amplifier on the drive PCB is damaged
EH09	Heating wire open circuit	There is an open circuit in the circuit of the heating wire
EH10	Abnormal heating wire current	Heating wire current becomes smaller

4.2. Common Faults And Troubleshooting

NO.	Issue	Cause analysis	Suggested solution
1	Seal Leakage.	Heating temperature is too low.	Raise the temperature setting.
2	Seal area is thin and easy to tear.	Heating temperature is too high.	Lower the temperature setting.
3	The air volume is low.	The amount of air is too small.	Increase the air volume setting.
4	Film break or film cut blurs.	The blade is worn out.	Replace the blade.







4.3. Engineering Interface Operation Instruction

4.3.1. First-level Engineering Interface Operation

1. MFB-B-11-21-10.0
 TMP:230 F-BROKEN:OFF
 BLW: 20 PRA-LOCK:ON
 SPD: 100 TMP-A.A.: AT

**MFB-B-11-21-10.0—APPLICABLE SPECIFICATION;
 TMP—TEMPERATURE ; BLW— BLOWING VOLUME;
 SPD—SPEED F-BROKEN—FILM-BROKEN ALARM;
 PRA-LOCK—PARAMETER LOCKING FUNCTION
 TMP-A.A—TEMPERATURE AUTOMATIC CORRECTION
 FUNCTION**

In the main interface state, press the temperature setting button , air volume button  and up arrow  at the same time, enter the engineering interface;

- a. Use the air volume key  and the film loading key  move the cursor to select the parameters to adjust;
- b. Click or long press the increase key  and the reduce key  Resize the value or select ON/OFF;
- c. ON=TURN ON,OFF=TURN OFF.
- d. Use the cursor to select the applicable specifications, and long press the increase key  and the reduce key  about 3 seconds, You can go to the next set of specification parameter settings;
- e. In the engineering interface, select the temperature automatic correction item **TMP-A.A.:** Including three values:

OFF (default) : Completely closed without correction.

MT: Continuously open, no automatic switching correction mode for room temperature.

AT: Automatic state, when the room temperature is $\leq 5^{\circ}\text{C}$, it will enter the 'cold state', and it will be displayed on the home page; when the room temperature is $> 8^{\circ}\text{C}$, it will enter the 'normal temperature state'.f.Press the stop key  to exit the interface.

4.3.2. Second-level Engineering Interface Operation





■ MFB - B-11-21-10.0

T.Re : 0 S.SP : 7

MFB—BUBBLE PILLOW CODE;B—BUBBLE PILLOW MATERIAL;11—BUBBLE PILLOW THICKNESS (um) ; 21—BUBBLE PILLOW WIDTH (mm);10.0—BUBBLE PILLOW LENGTH (mm)

T.Re: Temperature display correction value,Correction range 0~99 (Actual temperature = display temperature + correction value)

S.Sp: Motor stop time,default is 7; (Note: No adjustment is recommended without professional guidance)

- a. Use the blowing volume key  and the film loading key  move the cursor to select the parameters to adjust;
- b. Click or long press the increase key  and the reduce key  to adjust the parameters;
- c. Temperature display correction function: display the same temperature parameter value when different devices operate; Press the stop key  to exit the interface;

5. Specification

5.1. Basic Specifications

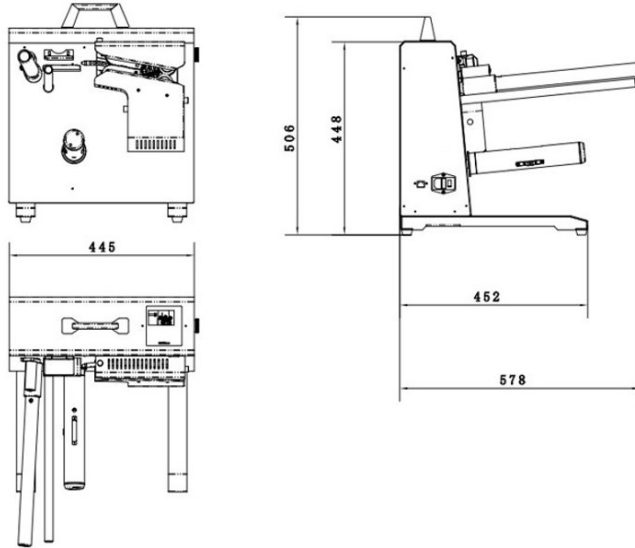

Main Body Parameters

Weight: 22kg (48.5 lbs)

Dimension: 445mm×578mm×506mm
(17.5 inches x 22.7 inches x 19.9 inches)

Package size: 535mm×565mm×385mm
(21.1 inches x 22.2 inches x 15.1 inches)

Lifetime of Machine: 5 years

Lifetime of Wearing Parts: 3 years

Working Temperature: 15°C~40°C (59°F~104°F)

Working Humidity: 10%~90%

Storage Temperature: -20°C~55°C (-4°F~131°F)

Storage Humidity: 10%~90%

Electrical Connections

Power Supply Voltage:

100V~120V/200V~240V

See the machine label for detailed parameters

Frequency: 50~60Hz

Power Supply: 450W

6. Maintenance

Please be sure to unplug the power plug.



- Please be careful of the sharp edges and corners of the machine to avoid injury.
- Never operate the machine when safety devices is off or removed.

The machine should be maintained at least once a week:

- Open the upper and lower cover
- Check if the screws used to install the power supply cable and short connecting of the heating wire is loose.
- Check if the installation position of heating wire is offset
- Clear the remaining dirty/foreign material on the rubber wheel and heating module
- Install the upper and lower cover
 - The machine must be inspected by a qualified person at least once a year

6.1. Repair/Replacement Parts

Repair should only be performed by a qualified service technician.

- When replacing parts, only  supplied parts can be used.
- Parts can be ordered by  's distributors.
- Failure to strictly follow the above instructions may affect the safety of the machine. The manufacturer disclaims no responsibility if the above instructions are not followed.

6.2. Replace Heating Belts

(1) Remove the upper and lower cover.

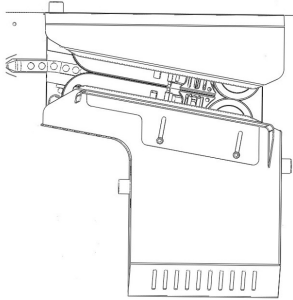

- a. Remove the upper and lower cover by removing the 3 screws (1 screw on the upper cover and 2 on the lower cover)

(2) Lift the Lifting Handle

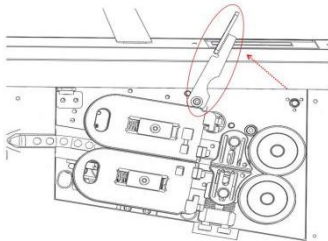

- a. Rotate the lifting handle counterclockwise until the handle is turned to the far left position, so that the two rubber wheels are separated from each other and the upper cooling block rises automatically

(3) Replace the belt.

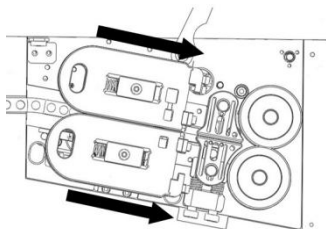

- a. Follow the arrow direction to push the upper heating wire mounting plate to the right, remove the heating belts from the right side, remove another heating belt in the same way.
- b. Load the new heating belt from the left and press to the heating belt block to install the heating belt. Install another one in the same way.

(4) Install the upper and lower cover.

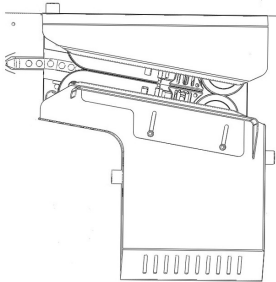

- a. Install the upper and lower cover by tightening the 3 screws.(1 screw on the upper cover and 2 on the lower cover)

6.3. Replace The Blade

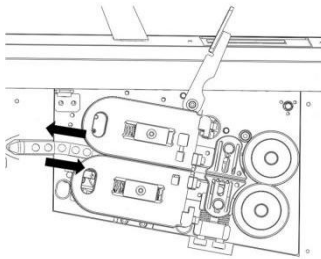

- a. Loosen the air nozzle fixing screw (no need to fully unscrew), holds the end of the nozzle to pull it out in the direction of the arrow.
- b. Remove the blade screw, replace the new blade (the blade is facing outwards), and tight the blade with screw (**Caution: Not to be cut by the blade**).

Push nozzle to the right in the direction of the arrow until the nozzle cannot move, fix the assembly with screw.





**For service contact Bingjia by email:
info@lockedair.com or call: +86 0571 86169196**